

INSTRUCTION MANUAL

ALARM CHRONOGRAPH MODULE



Table of Content

- ① Basic Information
- ② Setting the time(analogue)
- ③ LCD display, buttons position and operation mode switch
- ④ Power on reset
- ⑤ Time mode
- ⑥ Time setting mode
- ⑦ Daily alarm mode
- ⑧ Daily alarm setting mode
- ⑨ Chronograph mode
- ⑩ Count down timer mode
- ⑪ Count down timer setting mode
- ⑫ The second time zone mode
- ⑬ The second time zone setting mode
- ⑭ Care of your watch

Basic Information

1. Operating voltage: DC 3V
2. Clock frequency: 32768 Khz
3. 4 Buttons operation
4. 5 Function modes
 - a) Local time mode
 - b) Daily alarm mode
 - c) Chronograph mode
 - d) Count down timer mode
 - e) Dual time mode
5. Calendar year 2000~2049 auto adjustment
6. Alarms: 5 daily single alarm, sound for 10 seconds, & alarm 1 with snooze function (to repeat 7 times in the interval of every 5 minutes)
7. Hourly Chime
8. 12/24 hour format switching
9. Back light

Setting the time(analogue)

1. Pull the crown out one step, the second hand will stop.
2. Set the correct time by turning the crown.
3. Push the crown back to the original position. The watch will start running again.

The analogue indication and digital display of the time setting can be adjusted separately.

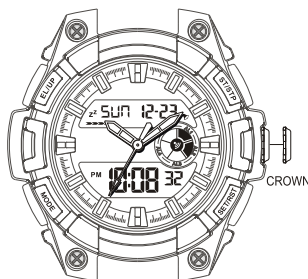

LCD display, buttons position and operation mode switch

1. LCD display as below



2. Buttons position

- (S1): Start/Stop/Adjust
 (S2): Set/Reset
 (S3): Mode/Select
 (S4): Up/EL

3. Mode transition

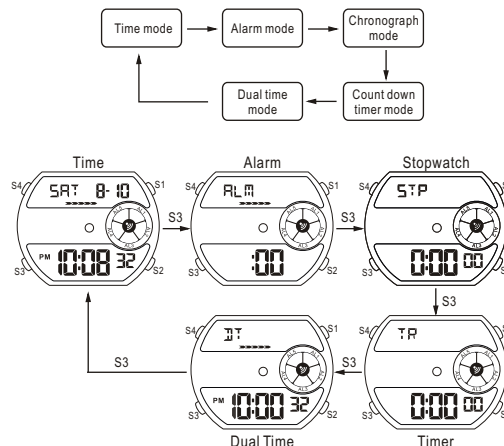

Remark:

If not under the time mode, press S1, S2 or S4 button and then S3 to go back to the time mode.

Power on reset

1. Time: 2005/01/01, Saturday ,12:00 AM , 12 hour format
2. Alarm: 12:00 AM Daily Alarm off, Hourly Chime off
3. Chronograph: 0:00'00"00 , off mode
4. Countdown timer: 00:00 00, off mode
5. Dual time: the same as the local time
6. Display: time mode

Time mode

1. Display as below



2. Button functions

- (S1): Switch between 12/24 hour format
 (S2): Hold to enter the time setting mode
 (S3): Enter the alarm mode
 (S4): Press to activate EL for 2 seconds

Time setting mode

1. Button functions

(S1): Select the setting items in turn as below

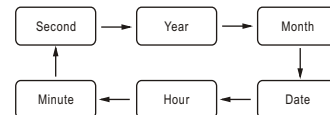

(S2): Exit the time setting mode

(S3): Select the setting items in turn as below

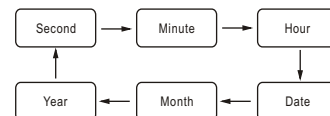

(S4): Increase the setting item, hold over 1 second to advance continuously at 4 Hz speed

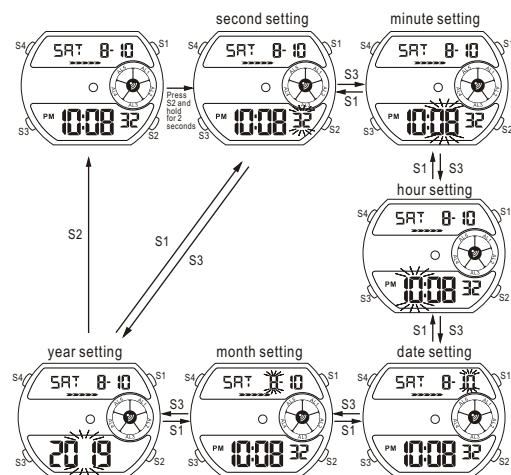

Remark:

- (1) Set seconds to 00, if after 30 seconds, MIN will increase, otherwise not change.
- (2) Auto adjustment for the week.
- (3) The current setting item is flashing at 1HZ speed.
- (4) Under the setting mode, if no button operation in one minutes, the display will exit the setting mode and get back to the time mode automatically.

Daily alarm mode

1. Display as below



2. Button function

(S4): Select the setting items in turn as below

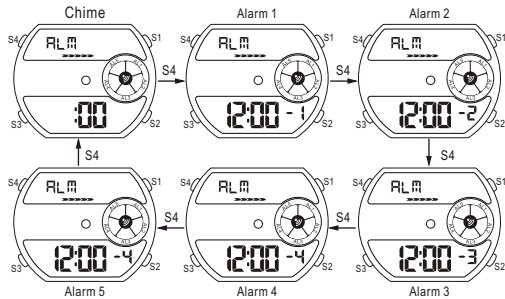
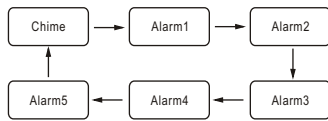

(S1): Under the chime mode ---- chime function on/off.

Under Alarm-1 mode ---- snooze function and Alarm 1 to be on/off in cycle.

Under Alarm2~Alarm5 mode ----Alarm2~Alarm5 on/off.

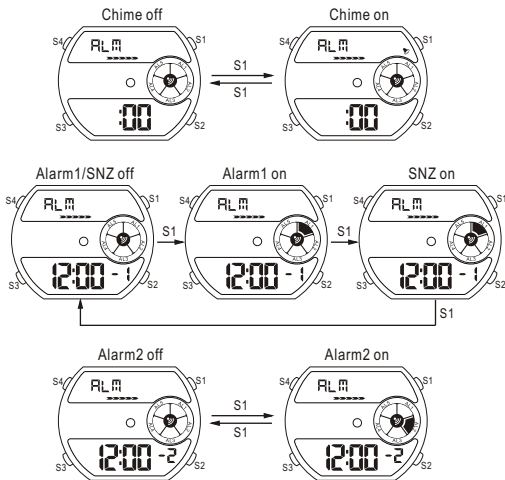

(S2): No function in the chime mode, while press and hold to enter the alarm setting mode under the Alarm~Alarm5 mode.

(S3): Enter the chronograph mode or return to the time mode.

Daily alarm setting mode

1.Button function

(S1/S3): Select the setting items in turn as below.

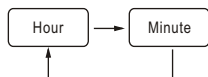

(S4): Hold the button for 1 second to enter the increasing setting, it will automatically increase in 4HZ speed.

(S2): Exit the daily alarm setting mode.

Remark:

- Current setting item is flashing in 1HZ frequency
- Under the setting mode, if no button operation in two minutes, the display will exit the setting mode.
- When the daily alarm function is disabled, once entering the setting mode, the alarm function will be enabled at the same time.

Chronograph mode

1. Display as below

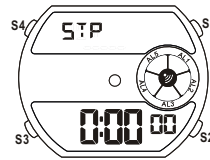

Maximum 23 hours 59 minutes 59 seconds and 99/100 seconds, it will automatically counting in cycles.

2. Button functions

- (S1): Start/Stop
- (S2): Split/Reset
- (S3): Entering the count down timer mode or go back to the time mode.
- (S4): Press to activate EL for 2 seconds

3.Under the chronograph initial mode or stop mode.

Button functions:

- (S1):Enter the chronograph running mode.
- (S2):Reset to 0.
- (S3):Entering the count down timer mode or go back to the time mode.
- (S4):press to activate EL for 2 seconds.

4.Chronograph running mode.

Under the Running mode, [.] will flash at interval of 1HZ.

Button function:

- (S1): Enter Chrono Stop mode.
- (S2): Enter Chrono Split mode.
- (S3): Enter the countdown timer mode or return to the Time mode.
- (S4): Press to activate EL for 2 seconds.

5.Chrono Split mode

Under the Split mode, [.] will flash at the interval of 1HZ

Button function

- (S1): Enter the Chrono Split-Stop mode.
- (S2): Enter the Chrono Running mode.
- (S3): Enter the countdown timer mode or return to the Time mode.
- (S4): Press to activate EL for 2 seconds

6.Chrono Split-Stop mode:

Under the Split-Stop mode, [.] will stop flashing

Buttons function:

- (S1): Enter the Chrono Split mode.
- (S2): Enter the Chrono Stop mode, display update to current timer.
- (S3): Enter the countdown timer mode or return to the Time mode.
- (S4): EL will be on for 2 seconds.

Count down timer mode

1. Display as below:

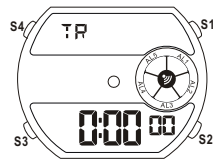

Buttons function:

- (S1): Start/Stop count down timer.
- (S2): When pressing the S2 button: if under the count down timer mode, there is no function; if under the stop mode of count down timer status, it will reset to the setting data.
- (S3):Enter the second time zone or return to the time mode.
- (S4):Press to activate EL for 2 seconds.

Count down timer setting mode

1.Buttons function:

(S4): Increase the setting item,hold over 1 second to advance continuously at 4 Hz speed.

(S2): Exit the count down timer setting.

(S1/S3): Select the setting item in cycle, in sequence as below:

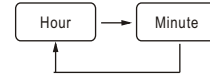

Remarks:

- Current setting item will flash in frequency of 1HZ.
- Under the setting mode, if no operation in 1 minute, will quit.
- The maximum count down timer is 23 hours 59 minutes and 59 seconds.

The second time zone mode

1.Display as below

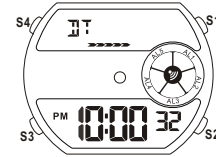

Buttons function:

- (S1): No function.
- (S2): Press and hold to enter the second time zone setting mode.
- (S3): Return to the time mode.
- (S4): Press to activate EL for 2 seconds.

The second time zone setting mode

Buttons function:

(S4):Increase the setting item,hold over 1 second to advance continuously at 4 Hz speed.

(S2): Quit the setting mode.

(S1/S3): Select the setting item in cycle, in sequence as below:

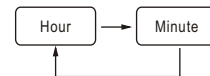

Remarks:

- Current setting item will flash in frequency of 1HZ.
- Under the setting mode, if no operation in 1 minute, will quit.

CARE OF YOUR WATCH

- This watch contains electronic components. Never attempt to open the case or remove the back cover.
- Do not operate push buttons below the surface of the water while swimming or diving.
- Should water or condensation appear in the watch, have the watch checked immediately. Corrosion of electronic parts can occur inside the case.
- Avoid severe impact.The watch is designed to withstand impact under normal use. It is inadvisable to subject it to severe impact or rough usage.
- Avoid exposing the watch to extreme temperature.
- Clean the watch with soft cloth and clean water only. Avoid using chemicals.
- Keep your watch away from the conditions of strong electric field and static electricity.